

PRODUCT SPEC SHEET/KEY SPECIFICATIONS

DORMER VENTS Model # DV2021-R

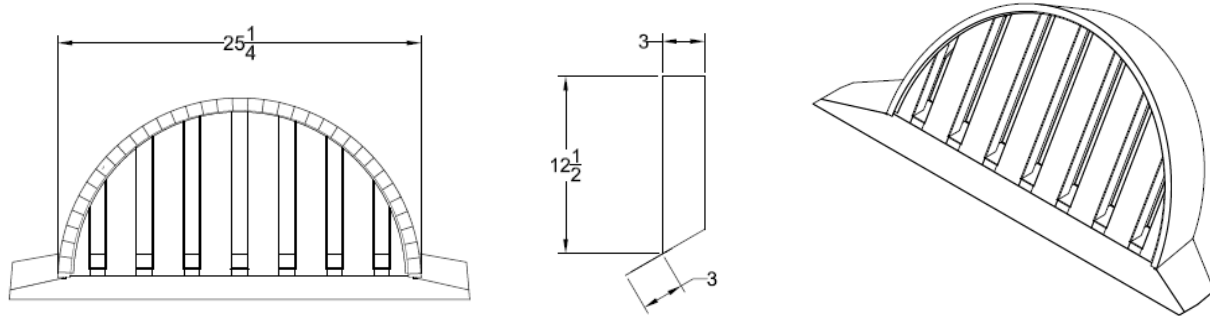

Under Eave/Soffit Vents	Model	Size W x H	NFVA Provided	Flanges Available	Flange Definition	Weight
	DV2021-R	12" x 24"	72	Standard	As Shown	7lbs
CUSTOM SIZES and materials AVAILABLE						

BENEFITS:

- Safety vents that are used in areas prone to wildfires, wind driven rain, or wind driven snow.
- Overlapping Baffle Protection (Patent Pending)
 - Air Flows through normally
 - Resists the intrusion of Flame and Embers, Wind Driven Rain and Wind Driven Snow
- Compliant with new California Ch7a Building Code
- 20 Year Warranty
- Easy Install

STANDARD MATERIALS

Astm A653/A653M- G90 hot dipped galvanized steel, 26GA
 ASTM D9092- mill phosphatized coating for painting. IF BONDERIZED
 ASTM b370- Sheet Copper, 16oz and 20oz IF GALVANIZED
 .025 x.025 hot dipped galvanized 23ga wire mesh

Installation:

- 1) Cut and remove existing horizontal louvers on existing Dormer Vent.
- 2) Place ample amounts of fire rated sealant behind 3" curved top flange of Dormer Retrofit.
- 3) Place Dormer Retrofit tightly into existing opening of old dormer vent. 3" curved top flange should go over the top of the existing dormer vent.
- 4) Secure with tapping screws 2" apart all along the entire 3" curved top flange.

NOTE: Always check local building codes for required NFVA/airflow minimums for attic spaces to ensure your retrofit meets code.